







# INSTALLATION INSTRUCTIONS FOR PREHUNG STORM DOOR

Tools & Materials You Will Need:			
• Measuring Tape		• Hammer	
• Level		• Hacksaw	
• Pliers		• Drill Bits - 3/32", 5/16"	
• Power drill		• Square	
• Stiff Utility Knife		• Pencil	
• Soft Mallet		• Phillips and flathead screwdrivers	
Installation Screwpack Contents:			
			
(1) pk #7 x 1" Phillips panhead screws	1) pk #6 x 1" Phillips panhead screws	1) pk #8 x 1 1/2" Phillips truss head screws	(2) #6 x 1/2" Phillips panhead screws - color matched
For hinge side of <b>leaf</b> z-bar mounted onto jamb	For exterior mounting of z-bar frame for both <b>leaf</b> and <b>piano</b> hinge z-bars	For hinge side of <b>piano</b> z-bar mounted onto jamb	For bottom expander

**REMEMBER: ALWAYS USE THE APPROPRIATE PERSONAL PROTECTIVE EQUIPMENT.**

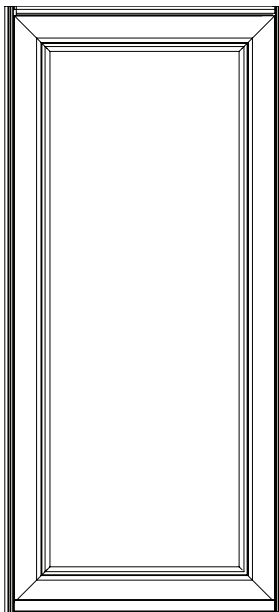

## Your Package Should Contain The Following Components:

Door slab with attached z-bars for header, hinge and latch side. Bottom expander will be attached to bottom of door slab. Screw cap covers, vinyl sweeps and hardware kit will ship inside door carton separately from door slab.



Version 4.6 - 03/18/10 - © 2010 ProVia Door - S-MK-30064



2150 State Route 39, Sugarcreek, OH 44681  
330.852.4711 330.852.2107 fax  
[www.proviadoor.com](http://www.proviadoor.com)



## **BEFORE YOU BEGIN INSTALLATION**

- Inspect your package(s) for any visible damage(s) to the product(s).
- If you have ordered extra optional items, make sure they are in the package before driving to the installation site.
- Make sure you have the appropriate tools before driving to the installation site.
- Make sure your rough opening is clear and free of any debris or rotted wood.
- As always, practice SAFETY and ensure your installation site is a SAFE WORKPLACE.

# 1

## **MEASURE & INSTALL**

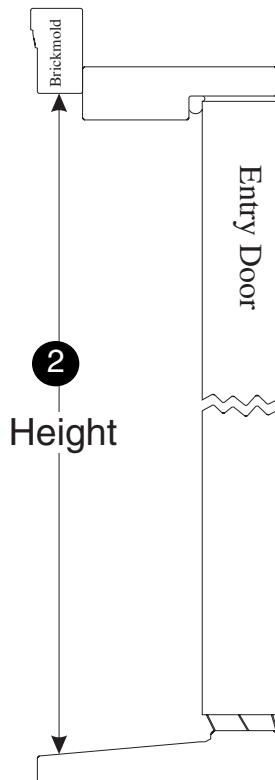

**Step 1** - Opening Width: Take three measurements from the inside of the brickmold: top, center and bottom of opening. Round the smallest measurement to the nearest  $\frac{1}{8}$ ", then RECORD THIS MEASUREMENT.

**Step 2** - Opening Height: Take three measurements from top of the opening to the sill: left, center, and right of opening. Round the smallest measurement to the nearest  $\frac{1}{8}$ ", then RECORD THIS MEASUREMENT.

**Note:** Take all measurements from outside the house.

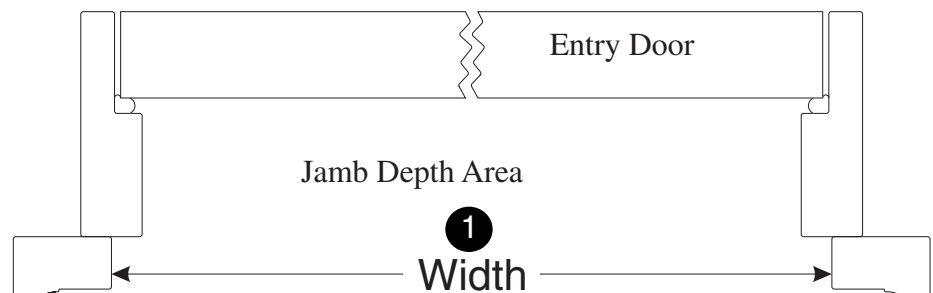

# 1

## MEASURE & INSTALL

1234567.001	
ORDER SIZE: 32 x 80	PKUP 150
901001 - PROVIA DOOR	LOAD: 10/06
MODEL: 397-DELUXE FULL VIEW	
PO #: PROVIA	TAG#: BACK
JOB: PROVIA	SUGARCREEK
<b>Quality Check</b>	
397-01 31 1/8 x 79 1/8 <b>3</b>	
<input checked="" type="checkbox"/> screw covers	
<input checked="" type="checkbox"/> screen	
<input checked="" type="checkbox"/> TAG: BACK	
<input checked="" type="checkbox"/> Right Hinged Pre-Hung	
<input checked="" type="checkbox"/> Snow Mist White	
<input checked="" type="checkbox"/> DH230 RH AB Contemporary Lever	
<input checked="" type="checkbox"/> Prep Left for Handset (Std 39")	
<input checked="" type="checkbox"/> DH305 White Hd Touch'hold Closer	
2 STD	SD1006A

**Step 3** - With the recorded measurements, verify with bar coded label on cardboard box and paperwork to make sure the size and order information is correct.

**Step 4**- Carefully unpackage the door, cut straps and remove cardboard.

**Step 5**- Lay door flat down with exterior side down.

**Step 6**- Remove glass and screen insert(s).



**Important!** You will receive the door with sash and screen mounted into door frame and secured with sash/screen clip mounted upside down .

Remove the mounted clips and lay aside being careful not to lose the clips.

There will be extra sash/screen clips with thumbscrews inside the hardware box to secure the sash/screen at each rivnut location.

Due to shipping restrictions, minimal sash/screen clips are mounted onto the door in production line. See Step 9 on page 12 for remounting the sash/screen clips appropriately.

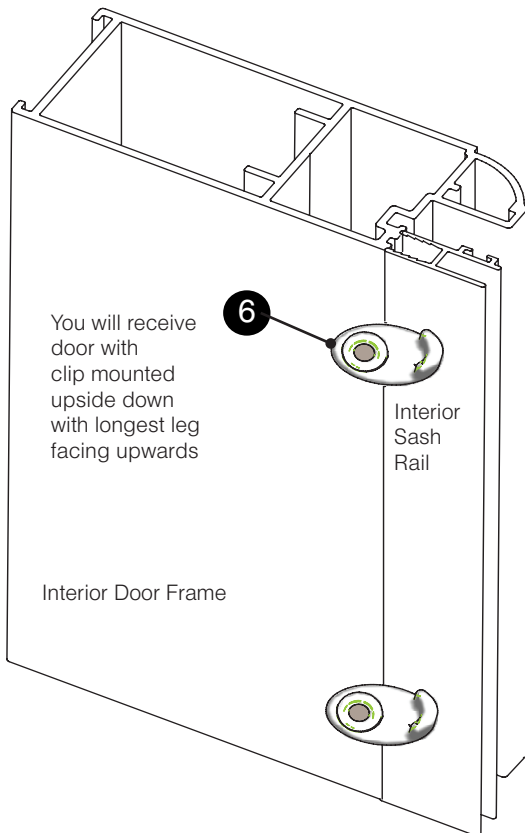

## 2 MEASURE FOR Z-BAR HEIGHT

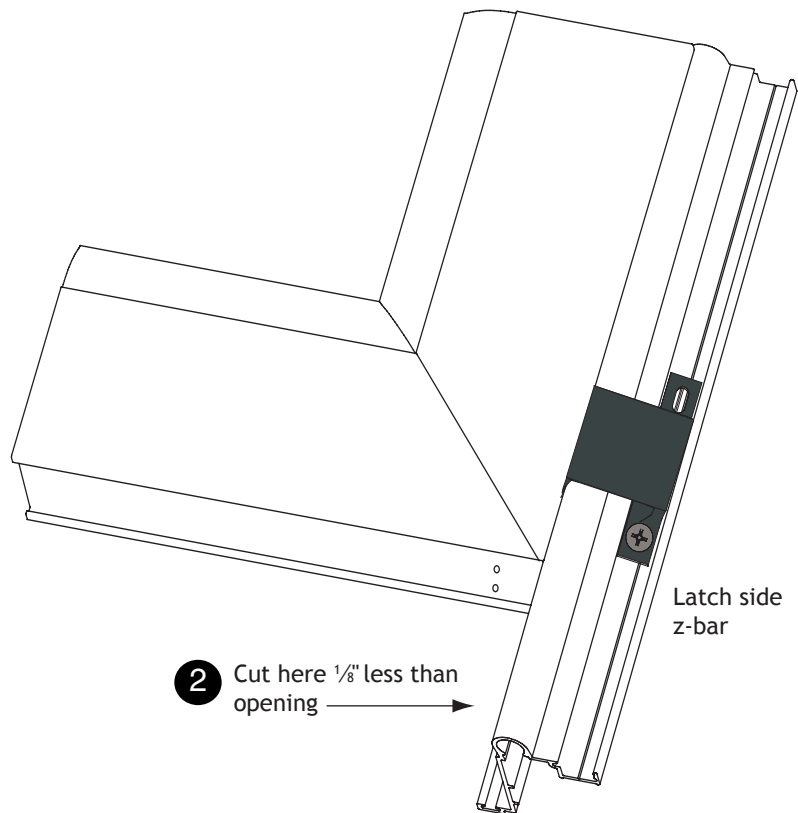

Note: If Eastern Z-Bar is ordered, a  $\frac{1}{4}$ " spacer has been attached to the rear side of the z-bar. At installation, drill  $\frac{1}{8}$ " holes through spacer using the installation holes in the z-bar as a guide.

**Step 1-** If you purchased a door with handleset prep, double check the location of the handleset prep and make sure it does not interfere with the prime entry door handleset.

**Step 2-** Subtract  $\frac{1}{8}$ " from opening height measurement. Using this result, measure the hinge and latch side z-bars from the top of the door. There are 2" of excess z-bar at the bottom of the door. Your measurement will fall in this area. Mark and cut the z-bars (see illustration).

**Step 3-** Wipe door slab down with a soft cloth to remove any metal burrs.

# 3 INSTALLING BOTTOM EXPANDER

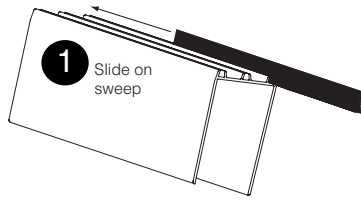

**Step 1-** Insert the vinyl sweep(s) into groove(s) at the bottom of the expander and pull it to the other end. See illustration for location of sweeps by model type.

**Note:** The vinyl sweep is packaged in the hardware kit. If the vinyl sweep has become kinked during shipment, place it in boiling water for 3 minutes and the sweep will return to its original shape.

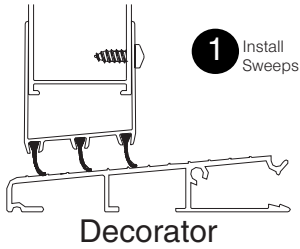

**Step 2-** Pinch the ends of the sweep groove(s) with pliers so the sweep will not pull out (see illustration)

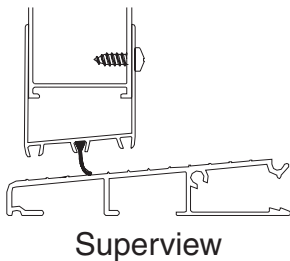
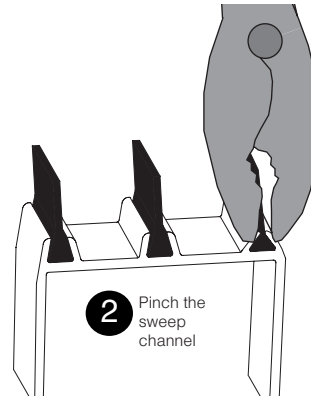
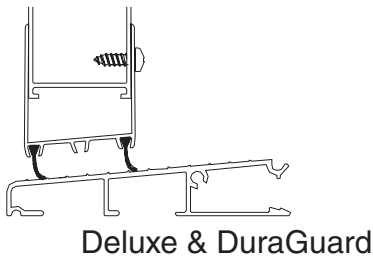

**Step 3-** Cut off the excess vinyl with scissors or a knife.

**Step 4-** Slide the bottom expander over the bottom of the door, pushing it onto the door as far as it will go.

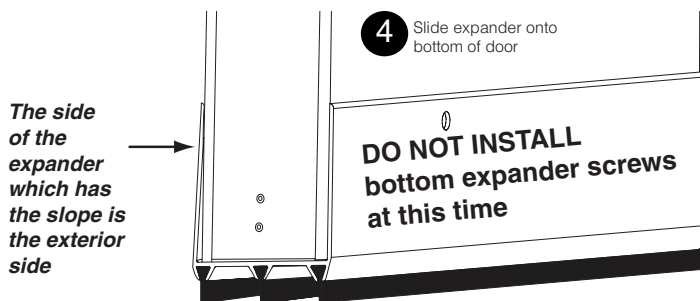

**Step 5-** *Do not install the screws.* The screws will be installed at time of final adjustment.

# 4 INSTALLING DOOR INTO OPENING



**Important!** It is very important to make sure door is centered into opening. It may be necessary to shim behind the z-bars in order to properly center the door.

**Note:** If Z-Bar build out (formerly called Eastern Z-Bar Adapter) is ordered, a 1/4" spacer has been attached to the rear side of the z-bar. At installation, drill 1/8" holes through spacer using the installation holes in the z-bar as a guide.

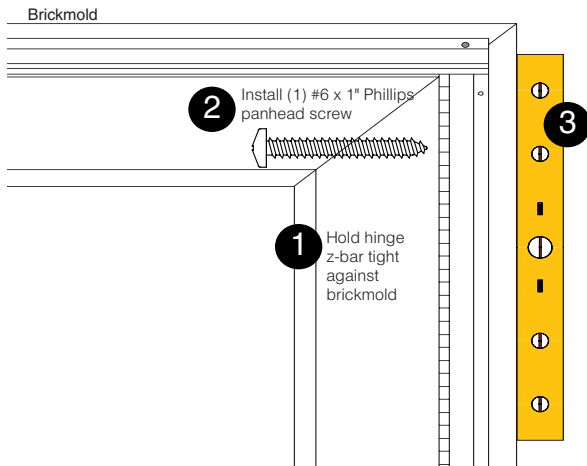

**Step 1-** Tilt the door into the opening making certain to center the door.

**Step 2-** Hold the door firmly in position and drill a 3/32" pilot hole through the very top of hinge side z-bar mounting hole and install (1) #6 x 1" screw.



**DO NOT OVERTIGHTEN SCREWS**

**Step 3-** Using a level, make sure the z-bar runs straight up and down, then drill and install the remaining screws.

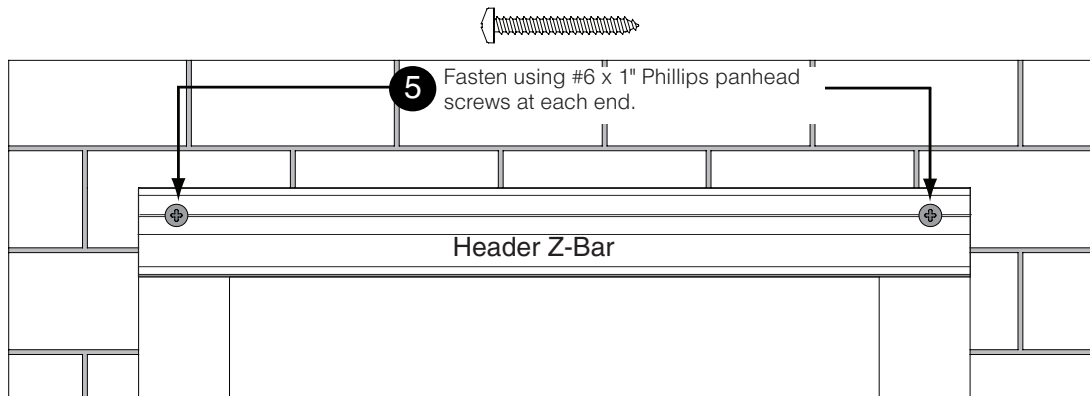

## Attaching Header Z-Bar

**Step 4-** Holding the z-bar header in place, drill a 3/32" pilot hole into the top trim board or brickmold through header mounting hole, maintaining approximately 1/8" clearance between z-bar header and door.

**Step 5-** Fasten the header firmly in place using #6 x 1" screws.

# 4 INSTALLING DOOR INTO OPENING

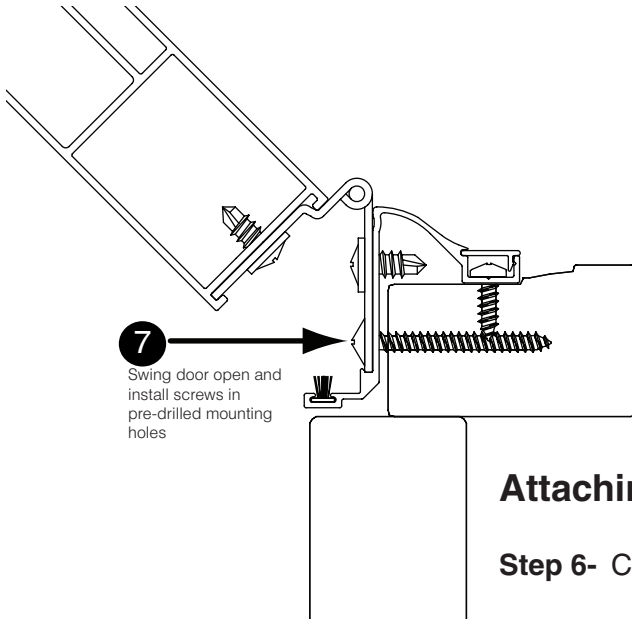

## Attaching Hinge Side Z-Bar

**Step 6-** Check and make sure the door operates properly.

**Step 7-** With the door open, locate the pre-drilled mounting holes in the z-bar and drill  $\frac{3}{32}$ " pilot holes through the mounting holes and install:

For Leaf Hinge:



For Piano Hinge:

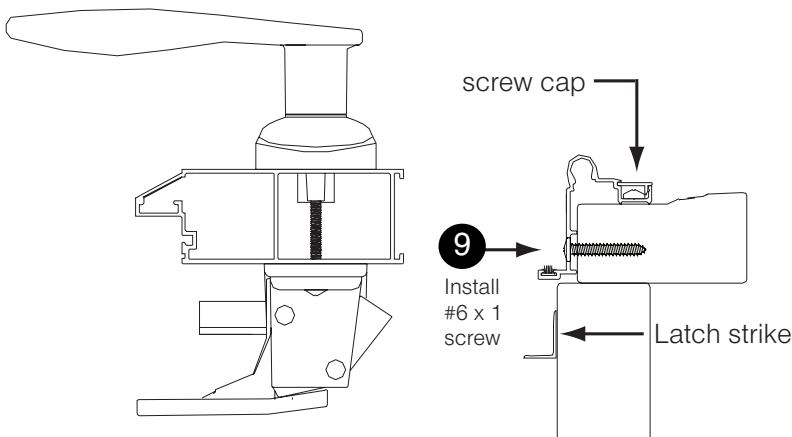

## Attaching Latch Side Z-Bar

**Step 8-** Cut and install latch side z-bar maintaining approximately  $\frac{1}{16}$ " clearance between the door and z-bar.

**Step 9-** Fasten with #6 x 1" screws

# 4 INSTALLING DOOR INTO OPENING

## Removing Pre-Hang Clips:



**Caution:** Do not use a tool to remove the pre-hang clips, doing so may cause damage to the door slab.

**YOU MUST ROTATE THE PRE-HANG CLIP COUNTER-CLOCKWISE TO REMOVE.**

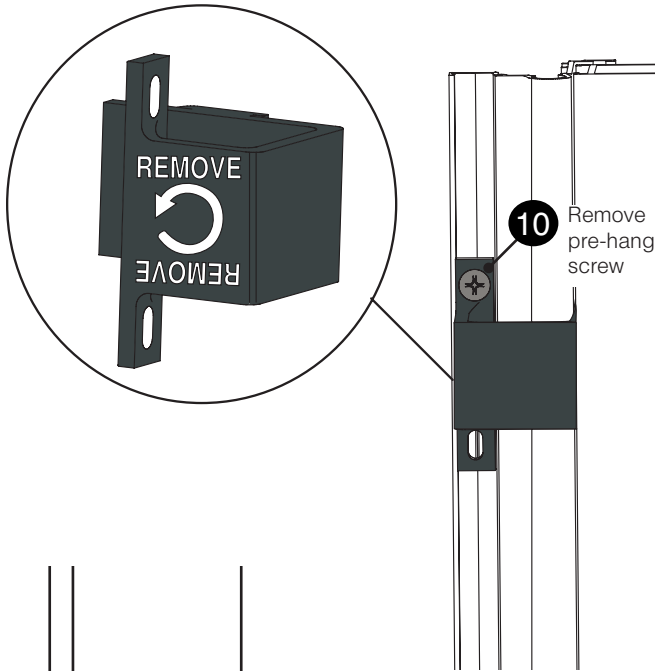

**Step 10-** After door has been installed, remove the (1) #8 x 1/4" Phillips panhead screw that is installed into each of the pre-hang clips.

**Step 11-** Allow the door to swing open.

**Step 12-** To remove the pre-hang clips, turn the pre-hang clip (see illustration) a 1/4 turn counter-clockwise by hand.

There will be 2 pre-hang clips at the top header and 3 pre-hang clips on the vertical latch side of the storm door frame.

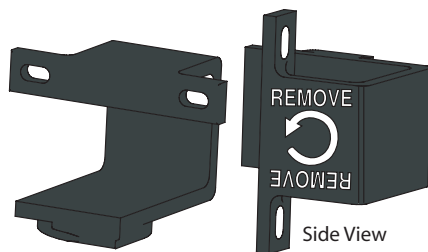
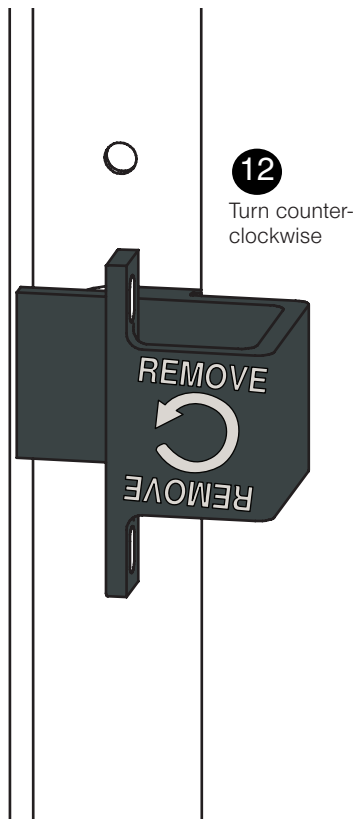

Pre-Hang Clip for Leaf or Piano Hinge Application

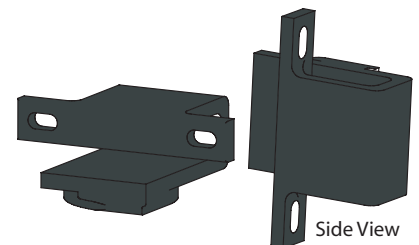

Pre-Hang Clip for Slim-Line Zbar Application

**Note:** The slim line z-bar application will use a slimmer pre-hang clip and will not have "Remove" on the clip.

## 5 FINAL ADJUSTMENTS TO BOTTOM EXPANDER

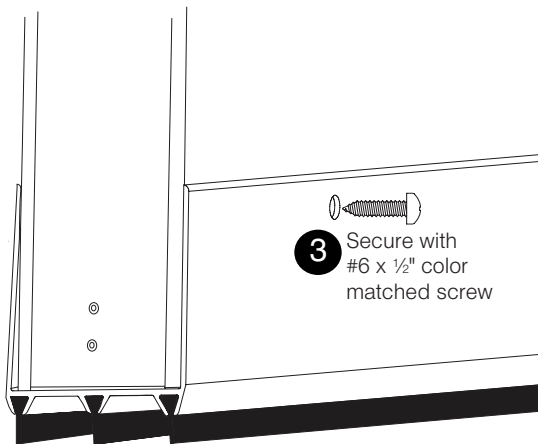

**Step 1-** Adjust bottom expander.

**Step 2-** Center pilot hole in slot of expander.

**Step 3-** Secure with (2) #6 x 1/2" color matched screws.

## 6 INSTALLING HARDWARE KIT

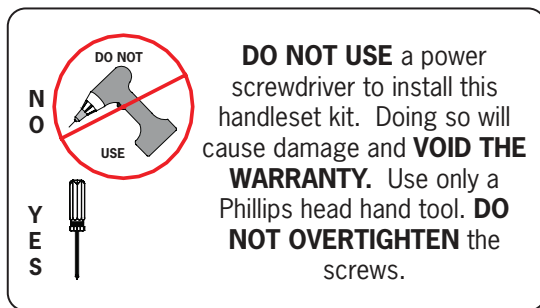

**Step 1-** Remove Template from handleset box and read manufacturer's instructions carefully.

**Note:** If you ordered a door already handleset prepped, you will not need to drill for template holes.

**Step 2-** Before drilling for handleset template, make certain the door slab is square in the opening and the location of the handleset will not interfere with the prime entry door handleset.

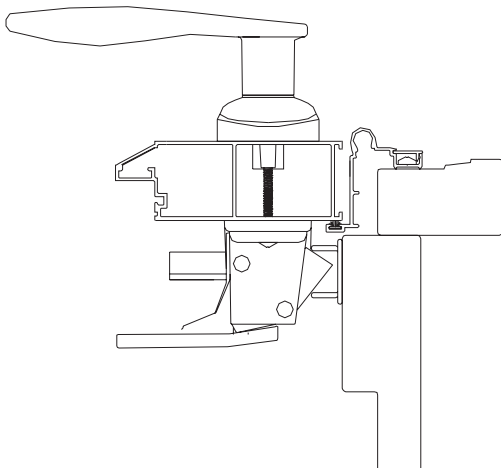

**Caution:** It is very important that you do not use a power tool to install the handleset (see illustration of label that is on your hardware box).

**Step 3-** Proceed with installation of handleset.

# 7 INSTALLING CLOSER KIT

## STANDARD CLOSER INSTALLATION

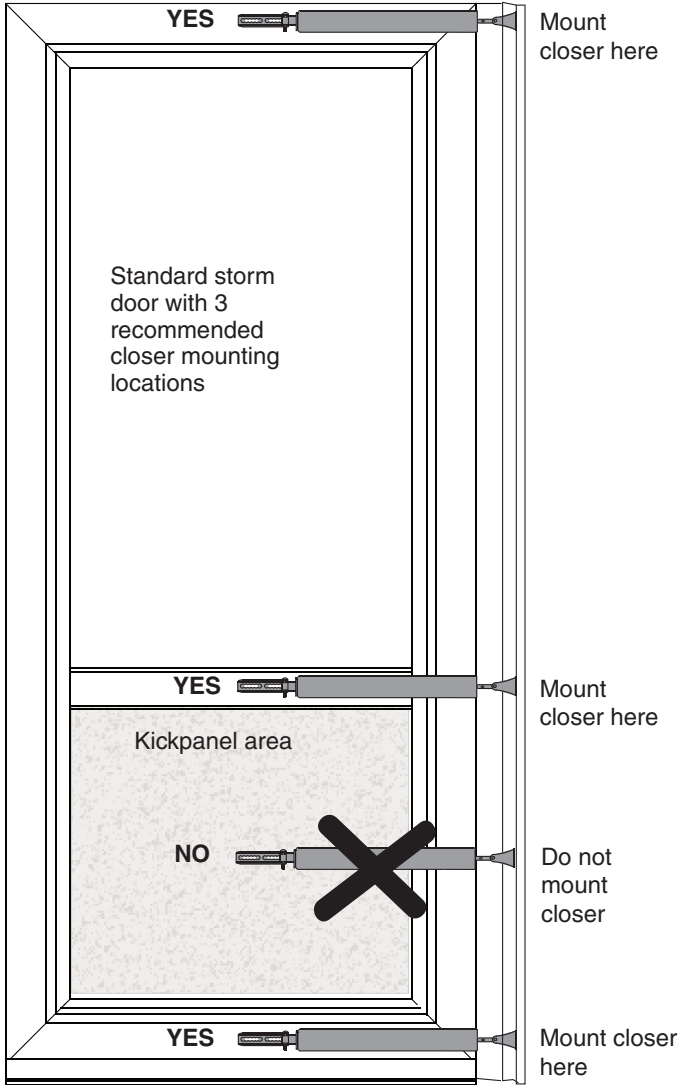

## PET DOOR CLOSER INSTALLATION

Mount closer **ONLY AT TOP OF DOOR FRAME**

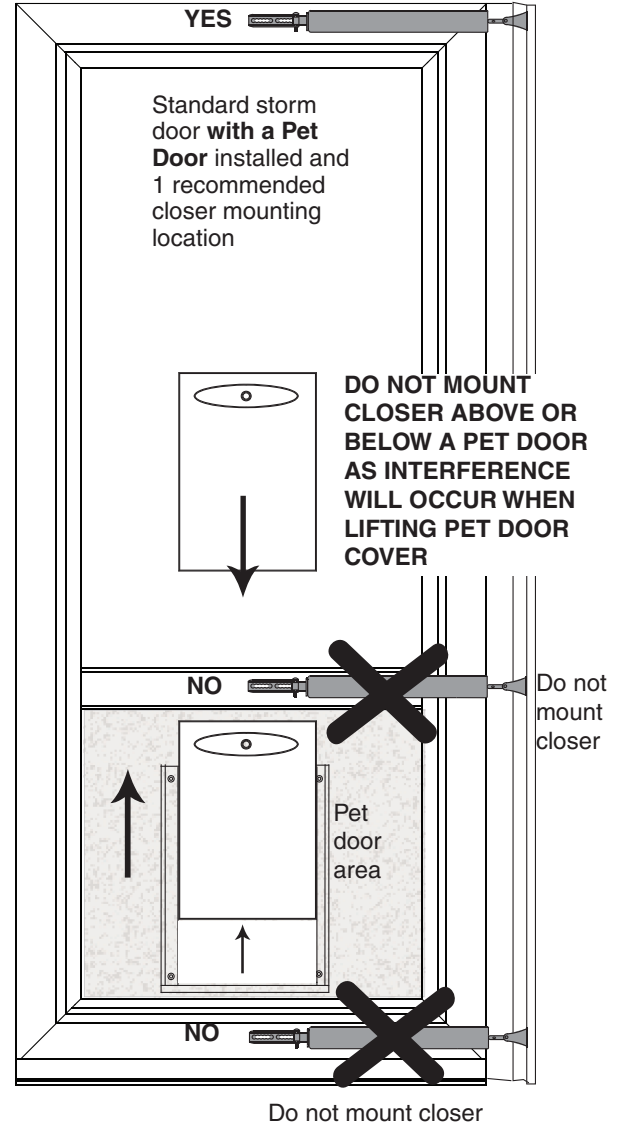

**Step 1-** Install closer according to manufacturer's instructions in the closer box. **DO NOT INSTALL CLOSER ABOVE A PET DOOR. DO NOT INSTALL A CLOSER ON A KICKPANEL.** See above illustrations for correct mounting locations.

**Step 2-** Adjust closer for the winter or summer setting by following the instructions from the manufacturer inside the closer box.

# 8

## **CLEANING & MAINTENANCE**

### **Glass Sash(s):**

To Clean the Glass Area that Contains Clear Glass or a Sungate 500® Low-E Coating:

- Use a soft, clean, high-absorbent, lint-free cloth.
- Utilize a 50/50 mixture of isopropyl alcohol (rubbing alcohol) and water. This evaporates more slowly than typical cleaners and will keep streaking to a minimum.
- Spray the cleaning solution on the glass surface to be cleaned. **Important!** do not wash the glass in direct sunlight.
- Wipe the cleaning solution off the glass using a circular motion applying light to moderate pressure to remove dirt residue.
- If this solution does not remove the dirt as desired, any household cleaner can be used; e.g., Windex™, Sparkle™, 409™, etc.
- If the household cleaners are used, reduce the area to be cleaned to more easily allow removal of the solution prior to evaporation (which is the cause of streaking). If streaks occur, reduce the area further.
- Products which foam or lather will help slow the evaporation of the cleaning solution and allow time to remove the residue. They may help 'lubricate' the surface which will give the cleaning cloth a more familiar feel, similar to uncoated glass.

### **To Clean the Aluminum Paint Finish:**

- Wash with a mild soap and water and treat like your new car finish.
- If finish is accidentally scratched or chipped, use touch up paint available from your dealer.
- To protect the finish, we recommend spraying the finish with a vinyl protector such as Armor-All® or use a high-quality auto wax and polish the surface.

### **For Decorative Brass Inlay:**

- Brass inlay will naturally oxidize with the outside elements. To keep the brass finish looking new, use a brass cleaner, such as Bon-Ami® brass cleaner.

### **For Brass Handlesets:**

If you purchased a handleset with a Bright Brass, Bright Brass Look or Satin Nickle Finish, these finishes are warranted against tarnishing for as long as you own and live in the home in which the product was installed. The mechanical defects are warranted for a period of (1) year from date of installation.

# 9

## FINAL ADJUSTMENTS

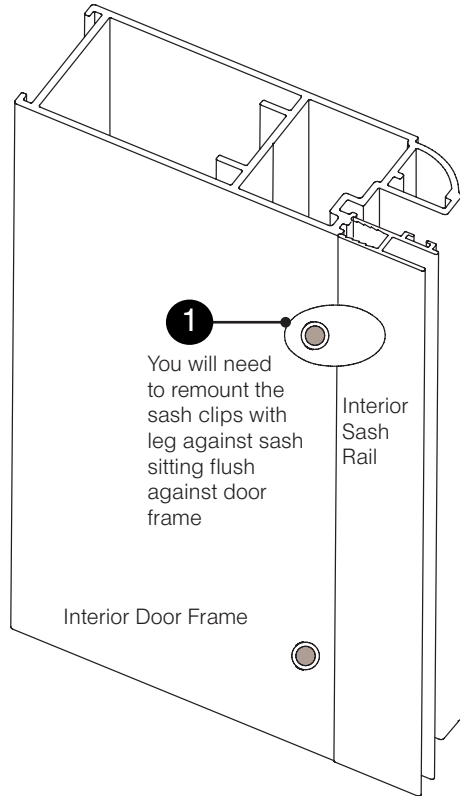

**Step 1-** Re-insert glass or screen insert(s). Remount the sash/screen clips with the longest leg securing the sash/screen to frame of door.

Additional sash/screen clips will be found inside the hardware box.

**Step 2-** Cut screw cap covers with a hacksaw sized to length of the z-bars for both vertical and horizontal pieces.

**Step 3-** Insert screw cap covers by using a soft mallet or gently tap the screw cap cover into the channel.

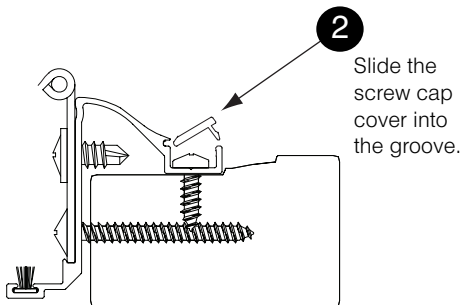

**Note:** Soap or other non-oily product can make the screw cap covers easier to install.

**Step 4** -Close door and inspect for proper fit and lock up.